

10

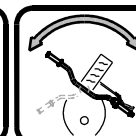

11

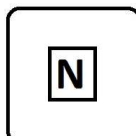
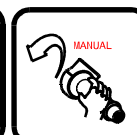
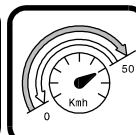
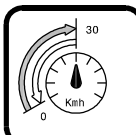

E-THROTTLE FOR DUCATI

LIMITATIONS



- ONLY FOR PROFESSIONAL FITTING
- SAFETY WARNING: if you don't follow entirely these instructions you may injure yourself, people and things.

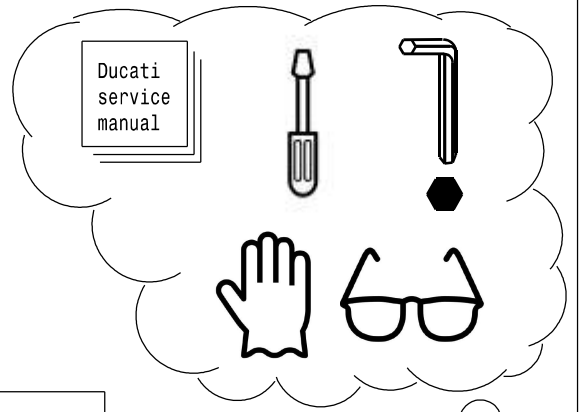

OK



- DUCATI MODELS:
- PANIGALE V4-V4S-V4R
 - STREETFIGHTER V4/S MY20
 - DIAVEL / XDIAVEL / S MY19
 - PANIGALE V2 MY20

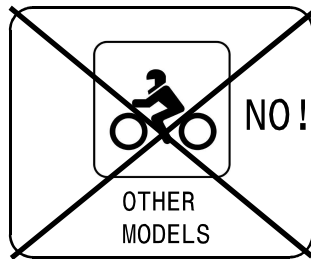

OK

RACING

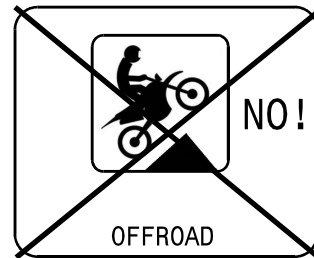
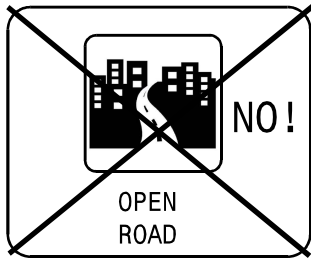

CRASH

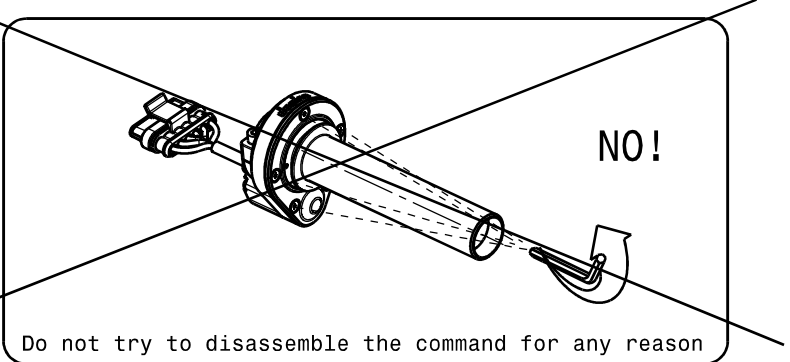

MAINTENANCE

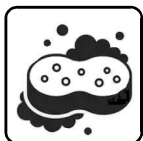

OK

SPONGE +
CAR SOAP

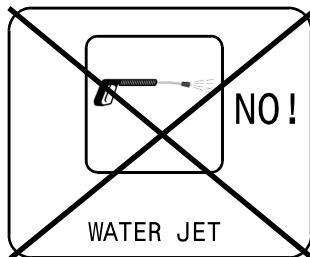

domino

Domino srl - Via delle Industrie, 16/18 - 23896 Sirtori (LC) - Italy Tel. +39 039 9211286 Fax +39 039 9210167



www.domino-group.com

Made in Italy

4079.02.6331-01

